

BM171 series



User Guide

BM171 AV Monitor User Guide

Contents

<i>Sample System</i>	<i>1</i>
<i>General Information</i>	<i>1</i>
<i>Safety Instruction</i>	<i>2</i>
<i>Features</i>	<i>2</i>
<i>Important Information</i>	<i>3</i>
PACKAGE CONTENTS	4
<i>Installation</i>	<i>5</i>
1.1. Mounting installation	5
1.1.1. Mounting with dash mount stand (option)	5
1.1.2. Mounting with headrest cushion (option)	6
1.2. Cable installation	7
1.2.1. Connect to power & ACC	7
1.2.2. Connect AV 1 cable to AV device	7
1.2.3. Connect AV2 cable to AV device	8
<i>Operation</i>	<i>8</i>
2.1. Control elements on the monitor	8
2.2. Power on/off	9
2.3. Volume setting	10
2.4. OSD Menu	10
2.5. Wired earphone	11
2.6. Touch screen (option)	11

BM171 AV Monitor User Guide

Figures

FIGURE 1 SAMPLE SYSTEM	1
FIGURE 2 PACKAGE CONTENTS	4
FIGURE 3 PRODUCT INSTALLATION KITS	5
FIGURE 4 BACK VIEW WITH MOUNTING STAND	5
FIGURE 5 JOINT VIEW WITH MOUNTING STAND	6
FIGURE 6 MOUNTING WITH HEADREST CUSHION	6
FIGURE 7 KEYLESS TOUCH BUTTON	8
FIGURE 8 OSD SETTING LIST AND DEFAULT VALUE	11

BM171 LCD AV Monitor User Guide

Sample System

Monitor

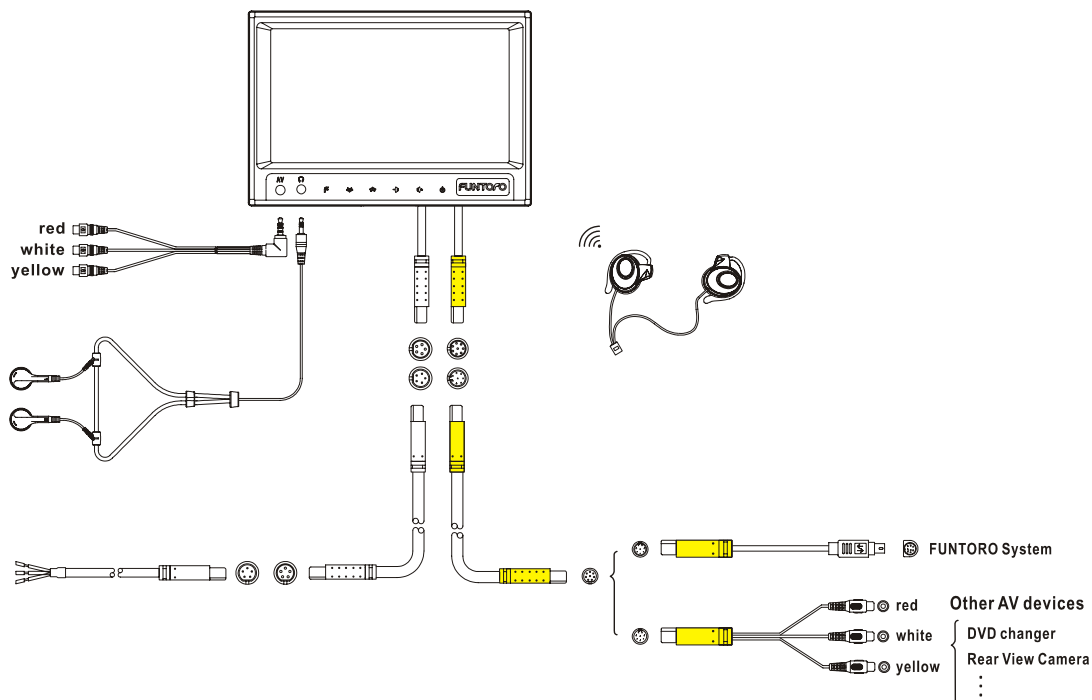

Figure 1 Sample system

General Information

Notes in installation and operating instructions

Please read this information carefully and follow all the instructions outlined below. This will ensure reliable operation and durability of your unit. Keep the packaging and operating instructions in a safe place in order to pass them on to a subsequent owner in the event of selling the unit at a later date.

The following reading aids are used to simplify these operating instructions:

- To ask you to perform an action.
- To show the unit's reaction.
- To provide extra info.
- Special notes or remark.
- To identify a list.

BM171 LCD AV Monitor User Guid

- ⚠ Safety instructions and warnings contain important information for the safe use of the unit. Failure to observe this information may result in material damage or personal injury. Therefore, please observe this information with particular care.**

Safety Instruction

- ⚠ For safety reasons, the driver should not watch TV/Media/DVD or similar while driving. Please note that it is illegal in certain countries to watch or to operate a TV, media, game, GPS or similar device while driving.**
- ⚠ Only use the product for its intended purpose.**
- ⚠ Do not clean using cleaning fluid, alcohol or other solvents. Use only a damp cloth.**

Features

- 7-inch 16:9 TFT-LCD color monitor
 - Resolution: 480 x 234 pixels (horizontal x vertical)
 - PAL/NTSC compatible (automatic detection)
 - OSD menu
 - AV connection via cinch/RCA (video and audio L/R)
 - 5 display modes support
 - Built-in loudspeaker and infrared earphone
 - Stereo headphone output at the front of the monitor
 - Operation at monitor or via keyless touch control
 - Touch screen support(option)
 - Keyless touch button for OSD control
 - Full plate keyless stylish design
 - Stylish Piano coating in front cover.
 - Support 2 AV input by default. It can support extra 4 AV input with AS101 companion. (Refer to AS101 user guide)
 - Support GPS navigation with touch control by companionship with BN701.
- ☞ For road safety reasons, the driver displayed terminal of the product should have a locking function which blanks the screen whenever the vehicle is in motion. The picture of displayed terminal only appears when the vehicle is stationary and the parking brake is engaged.

Important Information

- ⚠ The system must only be installed by trained personnel.**
- ⚠ Observe automotive industry quality standards.**
- ⚠ Fire hazard. When drilling, take care not to damage concealed wiring harnesses, the fuel tank or fuel lines.**
- ⚠ Never drill into supporting or safety-relevant body parts.**
- ⚠ It is essential to observe the following when installing components in the passenger compartment.**
- ⚠ Ensure that the driver has a clear all-round view.**
- ⚠ Increased risk of injury in the event of an accident. Do not install components in the inflation range of the airbag or in areas where the head or knees may knock against them.**
- ⚠ Only install the unit in vehicles with a 12-V on-board voltage and negative pole on the vehicle body. Risk of malfunctions, damage and vehicle fire if installed in unsuitable vehicles.**
- ⚠ Do not damage safety system wiring (airbag etc.). (Wiring is normally specially marked, e.g. by labels.)**
- ⚠ Do not use test lamps to test the voltage, since excessively high currents can damage /destroy electronic components.**
- ⚠ Do not use any pinch or cut connectors. Solder all wiring connections. Insulate all solder points with shrink hose or insulating tape.**
- ⚠ Fit toothed washers at earth connections to the vehicle body. If necessary, remove paint and dirt beforehand. Subsequently, protect bare metal against corrosion.**
- ⚠ In order to ensure perfect installation, use only the original components supplied. The use of non-authorized components may result in malfunction.**
- ⚠ Do not install the unit in positions where it is exposed to high temperature, dust, dirt or excessive vibration (e.g. due to direct sunlight or heating vents).**

BM171 LCD AV Monitor User Guid

PACKAGE CONTENTS









<p>#1 Monitor</p> 	<p>#2 RCA cable</p> 
<p>#3 Extension cable for #6 power cable</p> 	<p>#4 Power cable</p> 
<p>#5 Extension cable for #4/#8 cable</p> 	<p>#6 User Guide</p> 
<p>#7 RCA cable (option)</p> 	<p>#8 8-pin to ST101 control cable (option)</p> 

Figure 2 Package contents

※ Actual products' appearance might vary slightly from the pictures shown.

Installation

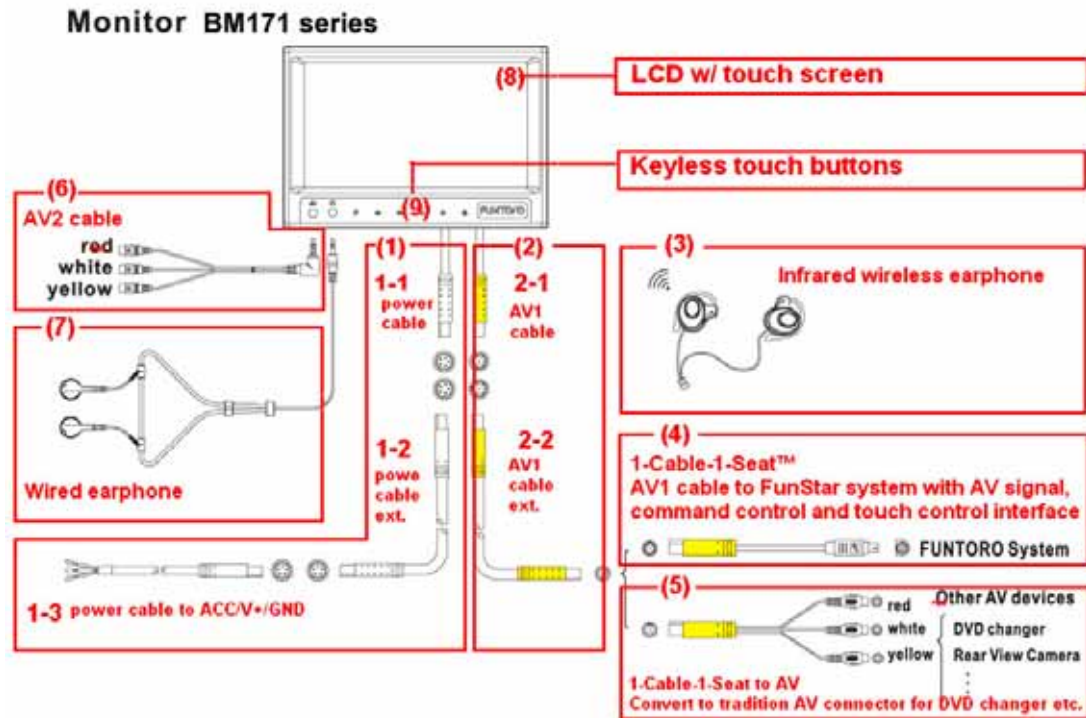

Figure 3 Product Installation kits

1.1. Mounting installation

1.1.1 Mounting with dash mount stand (option)

1. Slide monitor onto dash mount and then tighten using fastener.(Optional)

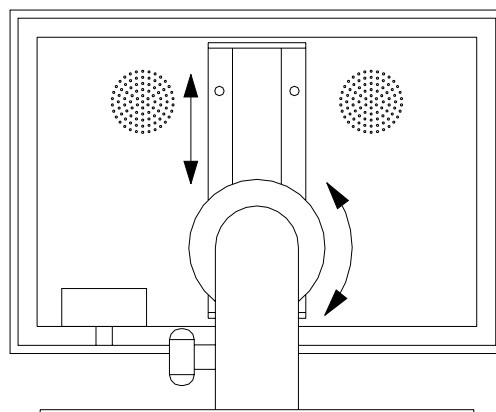

Figure 4 Back view with mounting stand

BM171 LCD AV Monitor User Guid

2. Firmly attach dash mount on a flat surface and adjust viewing angle of monitor by tightening the fastener.

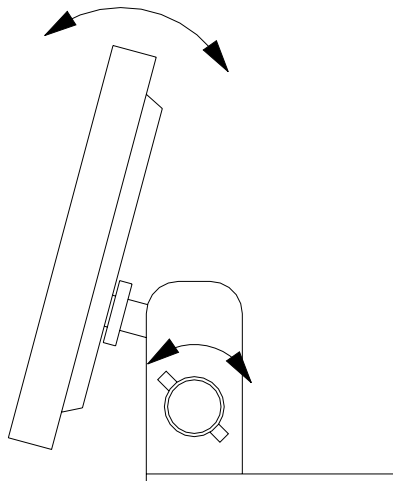

Figure 5 Joint view with mounting stand

1.1.2 Mounting with headrest cushion (option)

1. To install the monitor into the headrest cushion, you must ensure that the monitor connecting cable assembly has already pull through via the supporting pipe.
2. Before connecting the monitor, pull the connecting cable assembly through the headrest shroud as shown below.
3. Place headrest shroud into the opening and secure it with correct fasteners.

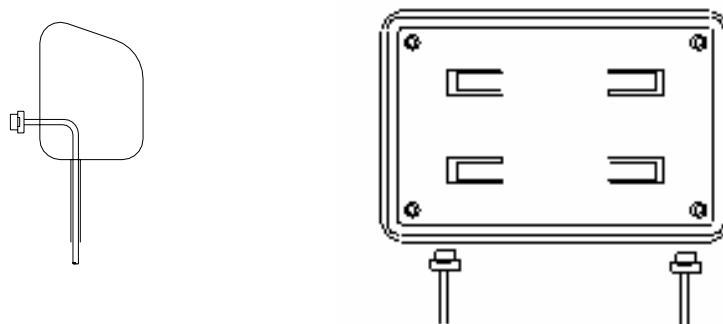

Figure 6 Mounting with headrest cushion

※ Installing Method of main cable assembly

1. Reeve the main cable assembly through (or beside) the head tube.
2. Secure and protect the cable assembly from damage when the headrest is adjusted.

BM171 LCD AV Monitor User Guid

3. Connect the connecting cables assembly to the monitor.
4. Ensure that there is no foreign material trapped inside the enclosure before pushing the monitor onto the headrest shroud .Make sure that the monitor is securely locked in place.

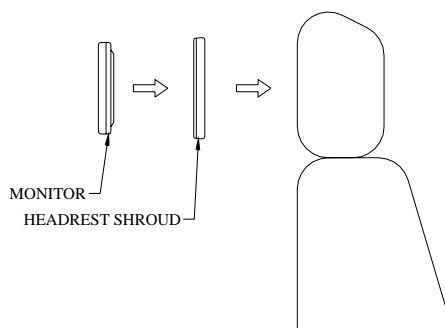

1.2. Cable installation

1.2.1. Connect to power & ACC

- ☞ Refer to 1-1 in Figure 3 Product Installation kit.
- ☞ Turn off car
- ☞ Install suitable power cables to 1-3 power cable in Figure 3 Product Installation kit. Suggest installing yellow power cable to battery V+ and black power cable to battery V-.
- ☞ Install ACC power cable from power ignition positive. Suggest installing red cable for the ACC cable.
- ☞ The amber power led shall be turned on while the product is turned on.

Power cable definition

Cable Color	Connection
Yellow	+12 V permanent positive terminal
Red	+12 V ignition positive / accessory contact / ACC
Black	Earth / GND

1.2.2. Connect AV 1 cable to AV device

- ☞ Refer to 2-1,2-2 in Figure 3 Product Installation kit.
- ☞ Install cable 2-2 in Figure 3 Product Installation kit inside the back of seat.
- ☞ Connect 1-Cable-1-Seat™ to 4 in Figure 3 Product Installation kit for FunStar Std. ST101 series product if ST101 series product is available in the installation. (Refer to ST101 user guide)
- ☞ Connect 1-Cable-1-Seat™ to 5 in Figure 3 Product Installation kit for AV devices, for example, DVD changer, PS3 Station or rear view camera etc..

BM171 LCD AV Monitor User Guid

1.2.3. Connect AV2 cable to AV device

- ☞ Refer to 6 in Figure 3 Product Installation kit.
- ☞ Connect external AV devices, for example, AV game, iPod or MP3/4 player to the AV2 cable.
- ※ The product can specify AV format-NTSC/PAL directly. It may have a quick flash while AV format is detecting.

Operation







2.1. Control elements on the monitor



Figure 7 Keyless Touch button

ID	Control elements on the monitor	Description
1.	Power/ 	☞ Power off (long period touch/press & hold)
	AV switch	☞ Power on/Source switch for DTV, GPS and AUX(short touch/click touch)

BM171 LCD AV Monitor User Guide

ID	Control elements on the monitor	Description
2.	Vol+ 	Increase volume
3.	Vol- 	Decrease volume
4.	Up 	<ol style="list-style-type: none"> BM171 series product OSD mode (refer to #6 in 2.1 Control elements on the monitor): <ul style="list-style-type: none"> ☞ up selection OSD item connect to ST101 series product (refer to #6 in 2.1 Control elements on the monitor): <ul style="list-style-type: none"> up selection OSD item ☞ Navigate main menu item of ST101 series product.
5.	Down 	<ol style="list-style-type: none"> BM171 series product OSD mode (refer to #6 in 2.1 Control elements on the monitor): <ul style="list-style-type: none"> ☞ down selection OSD item connect to ST101 series product (refer to main menu of ST101 user guide): <ul style="list-style-type: none"> up selection OSD item ☞ Navigate main menu item of ST101 series product.
6.	OSD 	☞ BM171 series product OSD item list(long period touch/press & hold)
	Main Menu	☞ Activate/Deactivate main menu of ST101 series product-refer to main menu of ST101 user guide(short touch/click touch)
7.	Earphone 	Connect to the wired earphone.
8.	AV2-IN 	Connect external AV device to AV2, for example, PS3 Station, DVD changer, iPod etc.

2.2. Power on/off

☞ Refer to 1 in 2.1 Control elements on the monitor

☞ There are 2 operation modes:

BM171 LCD AV Monitor User Guid

1. long period touch/press & hold:
 - ☞ Power on and the led turn into blue
 - ☞ Power off and the led turn into amber.
2. short touch/click touch
 - ☞ DTV/GPS/AUX source switch if ST101 is connected.

2.3. Volume setting

- ☞ Refer to 2,3 in 2.1 Control elements on the monitor
- ☞ Increase/Decrease volume setting if there is no OSD item on the screen. (Refer to 2.2.42.4 OSD Menu)
- ☞ Increase/Decrease setting value if there is any OSD item on the screen. (Refer to 2.2.42.4 OSD Menu)

2.4. OSD Menu

- ☞ Refer to 6 in 2.1 Control elements on the monitor
- ☞ There are 2 operation modes:
 1. long period touch/Press & hold:
 - ☞ List the OSD item for necessary setting.
 - ☞ Use keyless button 4,5 in 2.1 Control elements on the monitor. to up or down select the setting OSD item.
 - ☞ Use keyless button 2,3, in 2.12.1 Control elements on the monitor. to increase or decrease the setting value of OSD item.
 2. short touch/click touch
 - ☞ Toggle main menu of ST101 series product.
 - ☞ Use keyless button 4,5 in 2.1 Control elements on the monitor. to up or down select the main menu item of ST101 series product.

ID	OSD item	Description	RESET TO DEFAULT
1.	DIMMER	Monitor backlight lighting level	HIGH
		Value: LOW/MID/HIGH	
2.	BRIGHTNESS	Monitor brightness level	15
		Value:0-30	
3.	CONTRAST	Monitor contrast level	15
		Value:0-30	
4.	COLOR	Monitor color level	15
		Value:0-30	

BM171 LCD AV Monitor User Guid

ID	OSD item	Description	RESET TO DEFAULT
5.	HUE	Monitor hue level	15
		Value:0-30	
6.	WIDE SCREEN	Display aspect ration control	FULL
		VALUE: FULL/16:9/ZOOM1/ZOMM2/4:3	
7.	IR EARPHONE	Setup IR earphone channel	CH-A
		Value: CH-A/CH-B	
8.	INPUT SOURCE	AV1 & AV2 source selection	AV1
9.	SPEAKER	Turn on/off internal speaker	ON
		Value: ON/OFF	
10.	RESET TO DEFAULT	Reset the OSD item setting to the factory default value. Click Vol+ or Vol- in Control elements on the monitor to reset	

Figure 8 OSD Setting list and default value

2.5. Wired earphone

- ☞ Refer to 7 in 2.1Control elements on the monitor
- ※ The volume setting of OSD increases or decreases the speaker of the product only. The earphone volume can be controlled by earphone itself volume setup only.

2.6. Touch screen (option)

The product has touch screen option to companion with ST101 and BN701 series products.